

Evidence for Hard X-Ray Polarization from the Flare of 23 July 2002

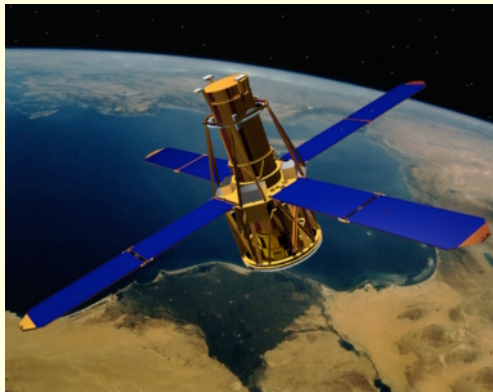

**Mark L. McConnell¹, David M. Smith², A. Gordon Emslie³,
Gordon J. Hurford², Robert P. Lin², and James M. Ryan¹**

¹Space Science Center, University of New Hampshire, Durham, NH

²Space Sciences Laboratory, U.C. Berkeley, Berkeley, CA

³Physics Department, University of Alabama, Huntsville, AL

Polarization in Solar Flares

The hard X-ray continuum is dominated by electron bremsstrahlung emission.

Measurements of hard X-ray polarization can shed light on the geometry of the acceleration process.

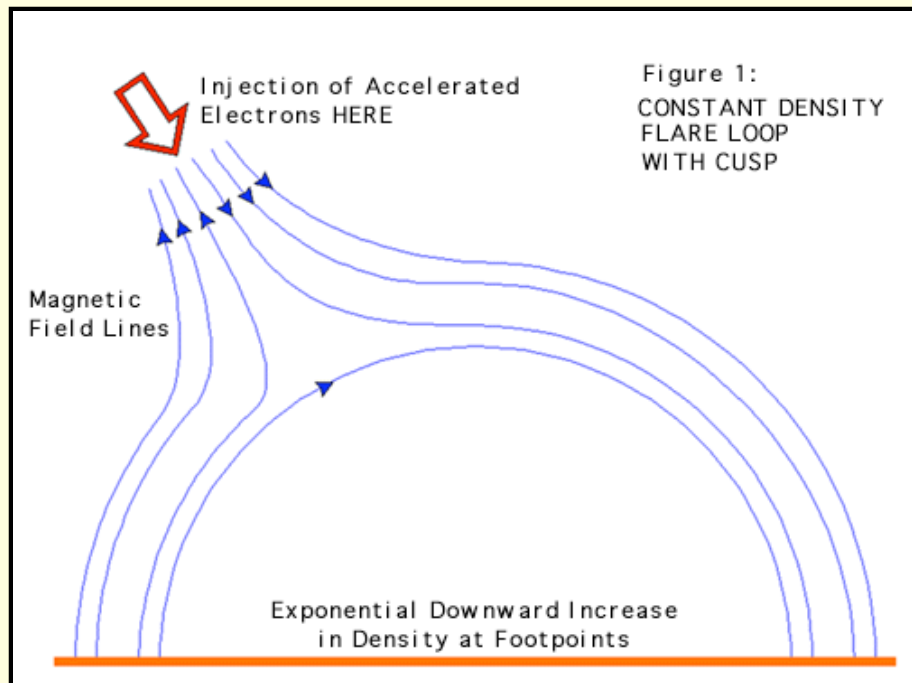

Model parameters include :

- 1) pitch angle distribution
- 2) B-field geometry
- 3) viewing angle
- 4) atm density profile

Models predict polarization levels as high as 20 or 30%.

The Polarization Signature

For a fixed Compton scatter angle (θ), the azimuthal distribution of scattered photons contains the polarization signature.

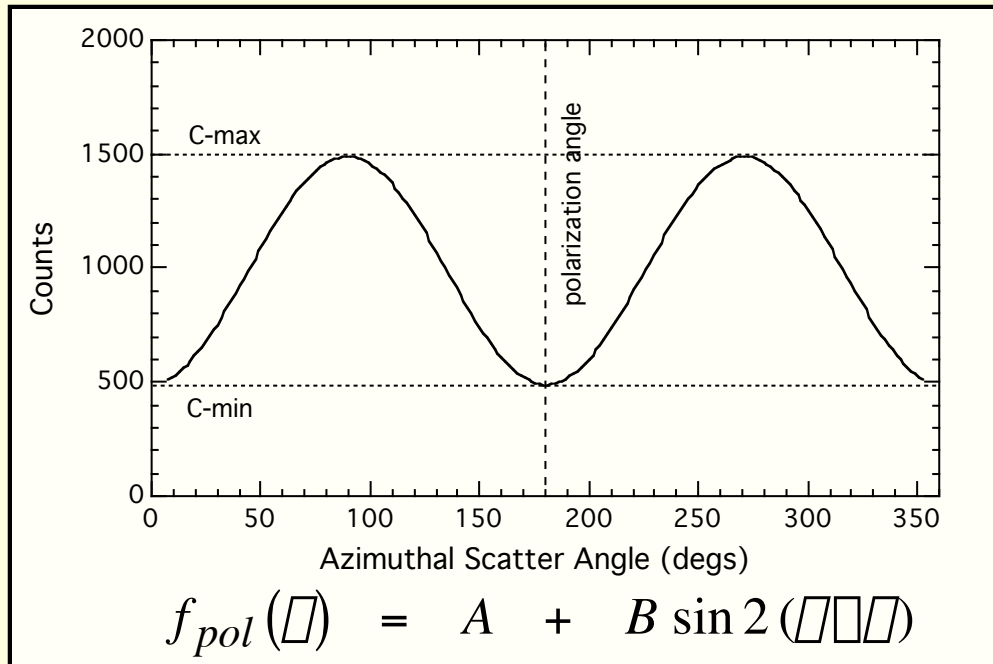

Modulation factor

$$Q = \frac{C_{\max} - C_{\min}}{C_{\max} + C_{\min}} = \frac{B}{A}$$

Polarization Measurement

$$P = \frac{Q_P}{Q_{100}}$$

The *amplitude* of the modulation defines the *level of polarization*.

The scattering angle corresponding to the *minimum* of the distribution defines the *plane of polarization*.

RHESSI as a Polarimeter (20 – 100 keV)

A small (3 cm diam by 3.5 cm high) cylinder of Be serves as scattering element.

The Ge detectors measure the distribution of the scattered radiation.

The rotation of the spacecraft rotation provides an effective method for fine sampling of the scatter distribution.

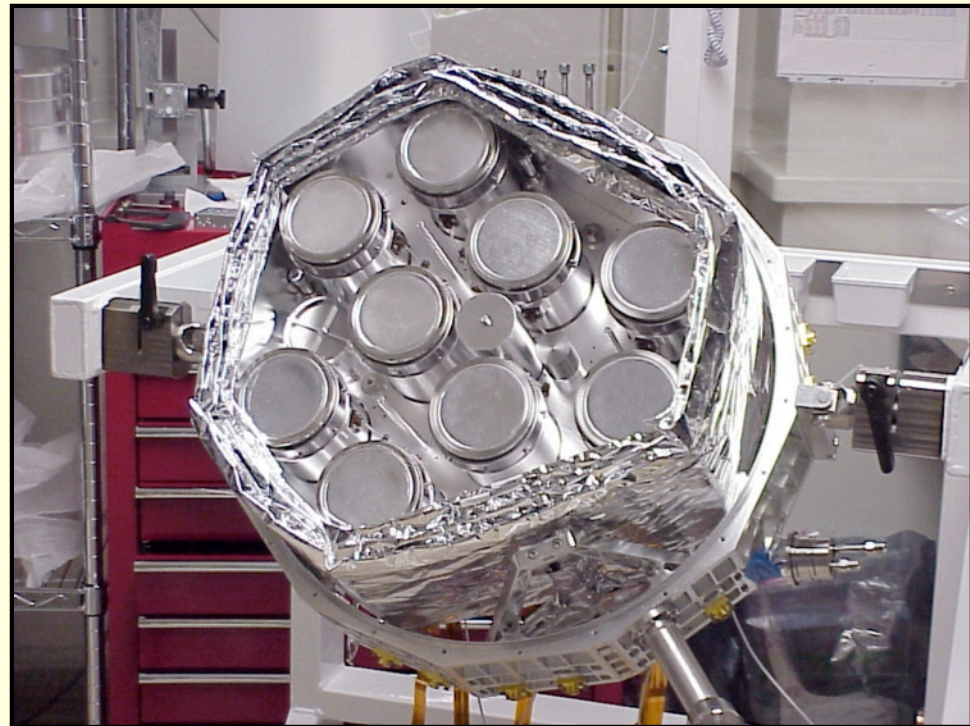
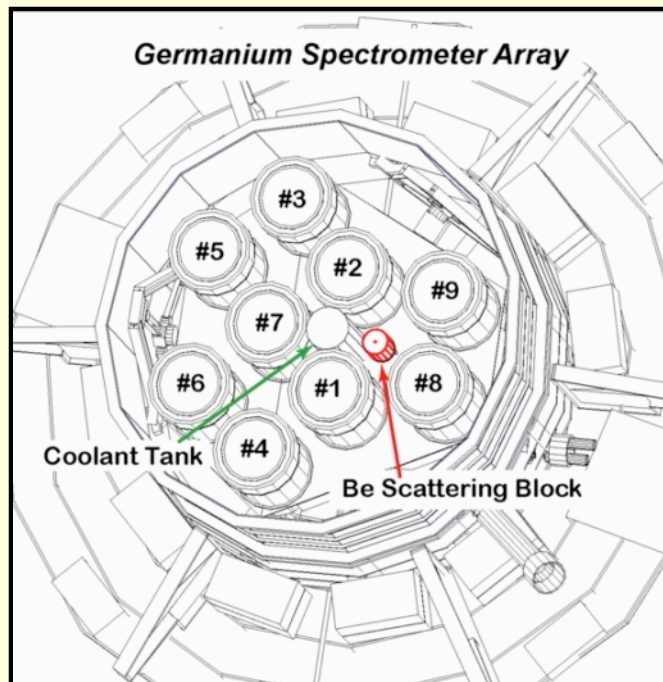

Segmented Ge detectors

The segmented nature of the Ge detectors means that low energy photons can reach the rear Ge segments only by scattering off other material.

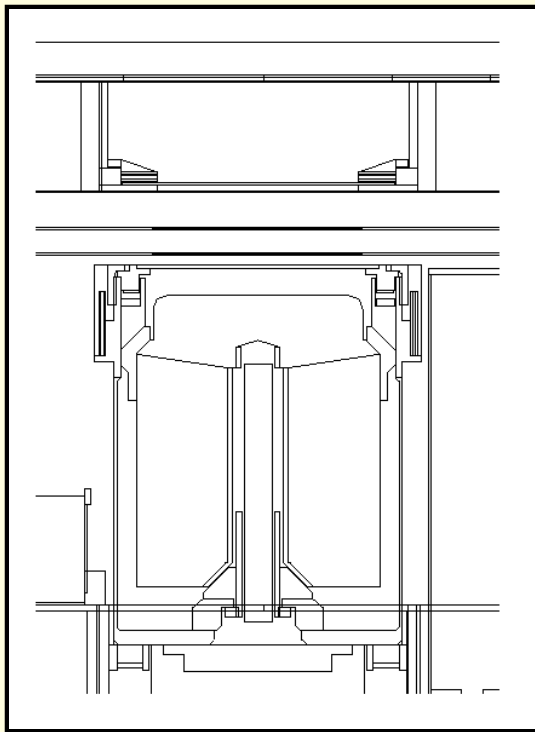

*Mechanical configuration
of a Ge detector.*

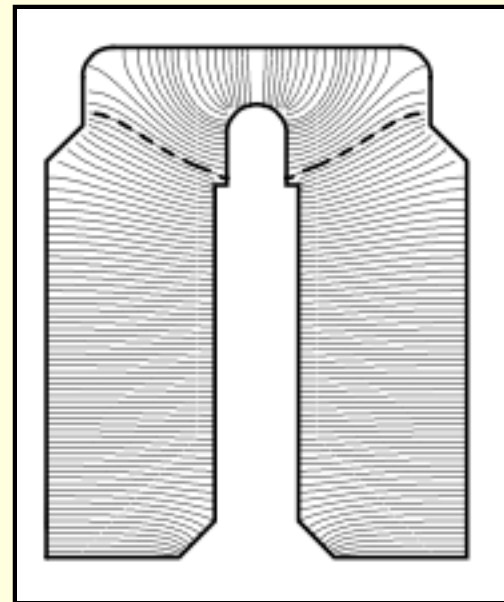

*Field geometry
of a Ge detector.*

The Polarization Signal - Simulation Results

We have used a modified version of GEANT3 to carry out Monte Carlo simulations of the polarimetric capabilities of RHESSI.

A valid polarimeter event is one which produces a measurable energy deposit in the rear segment of Ge detectors 1, 8, or 9.

Detector 2 is not currently operating as a segmented detector.

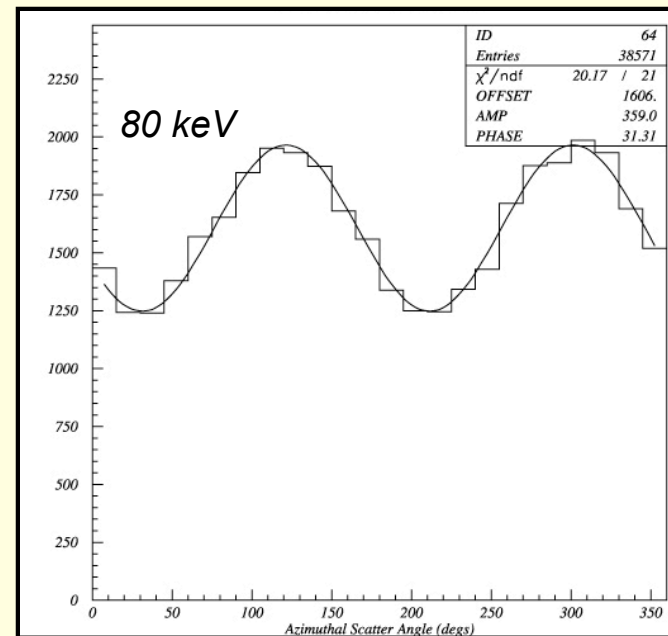
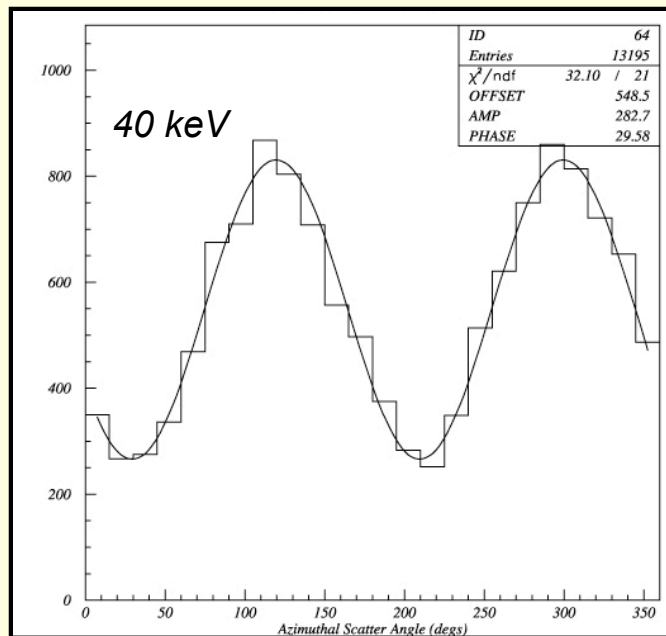

RHESSI Polarimeter Mode - Simulation Results

The Figure-of-Merit as defined here incorporates the effective area, the modulation factor and the relative background rate.

$$FoM = \frac{Q_{100} \text{ [A]}}{\sqrt{R_{bgd}}}$$

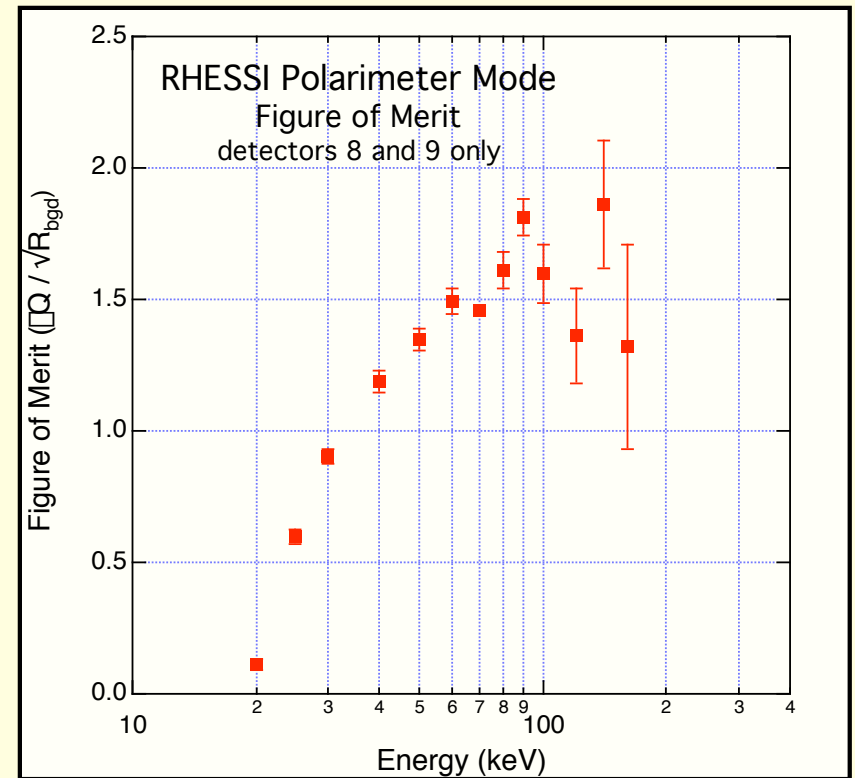
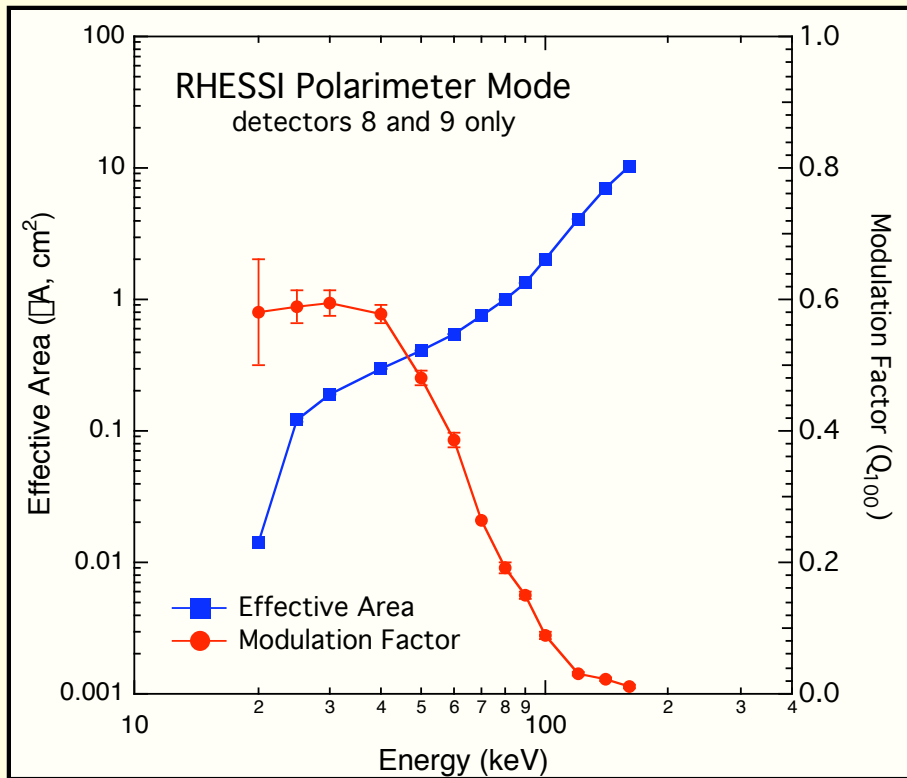

RHESSI Sensitivity to Solar Flare Polarization

Minimum Detectable Polarization (MDP)

	Event Duration				
	20	100	200	500	1000
	sec	sec	sec	sec	sec
<i>X2 class flare</i>					
20 – 40 keV	11%	5%	3%	2%	2%
40 – 60 keV	53%	24%	17%	11%	8%
60 – 80 keV	–	–	73%	46%	33%
<i>X10 class flare</i>					
20 – 40 keV	5%	2%	1%	1%	<1%
40 – 60 keV	17%	7%	5%	3%	2%
60 – 80 keV	61%	27%	19%	12%	9%

For M-class flares, sensitivity levels of 20-40% may still be achievable in the lowest energy bands.

Candidate Flare Events

There have been several X-class flares since the launch of RHESSI. The best candidate for polarization studies was the X4.8 event of 23-July-2002, which showed a large signal in the rear segments.

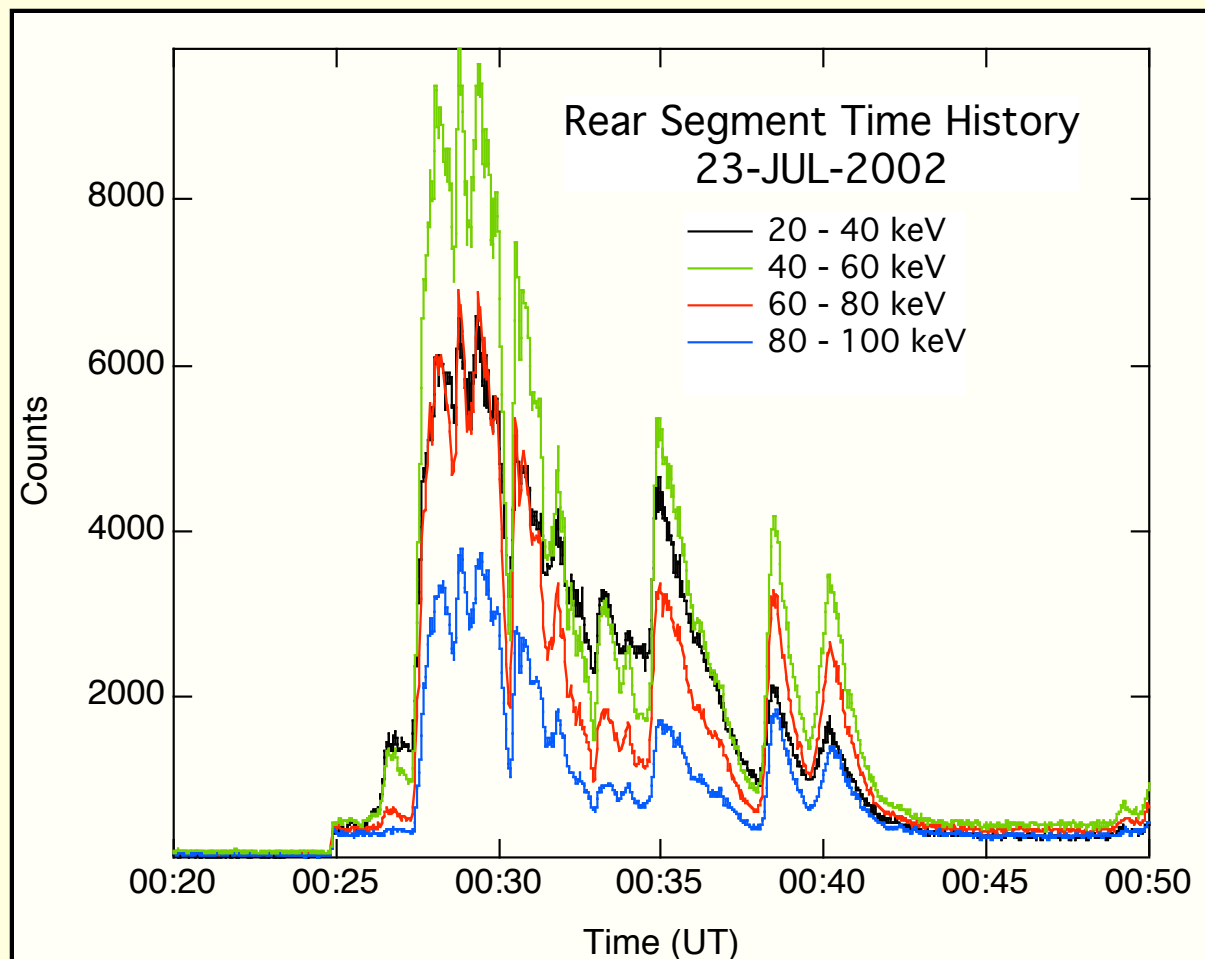

Nature of the RHESSI Data

**X4.8 Flare - 23 July 2002
00:26 – 00:42 UT**

**Rear Segment Data
(20 – 40 keV)**

**dominated by spin
modulation of atmospheric
background and albedo**

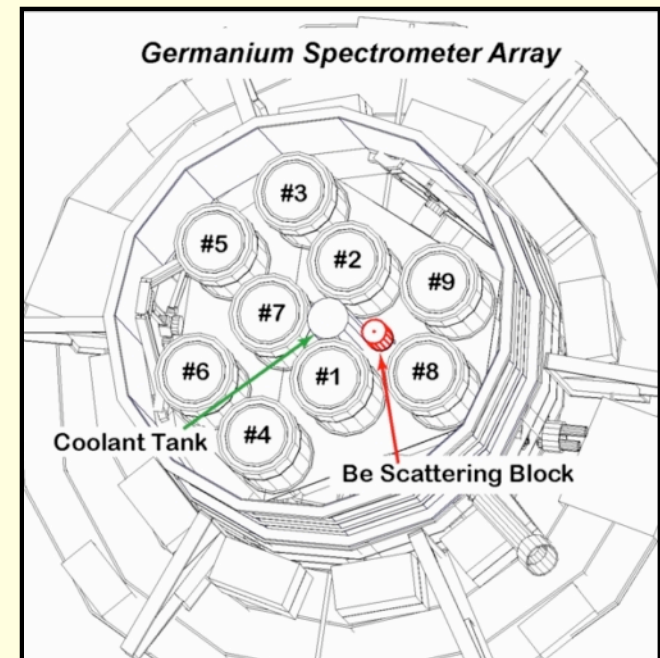
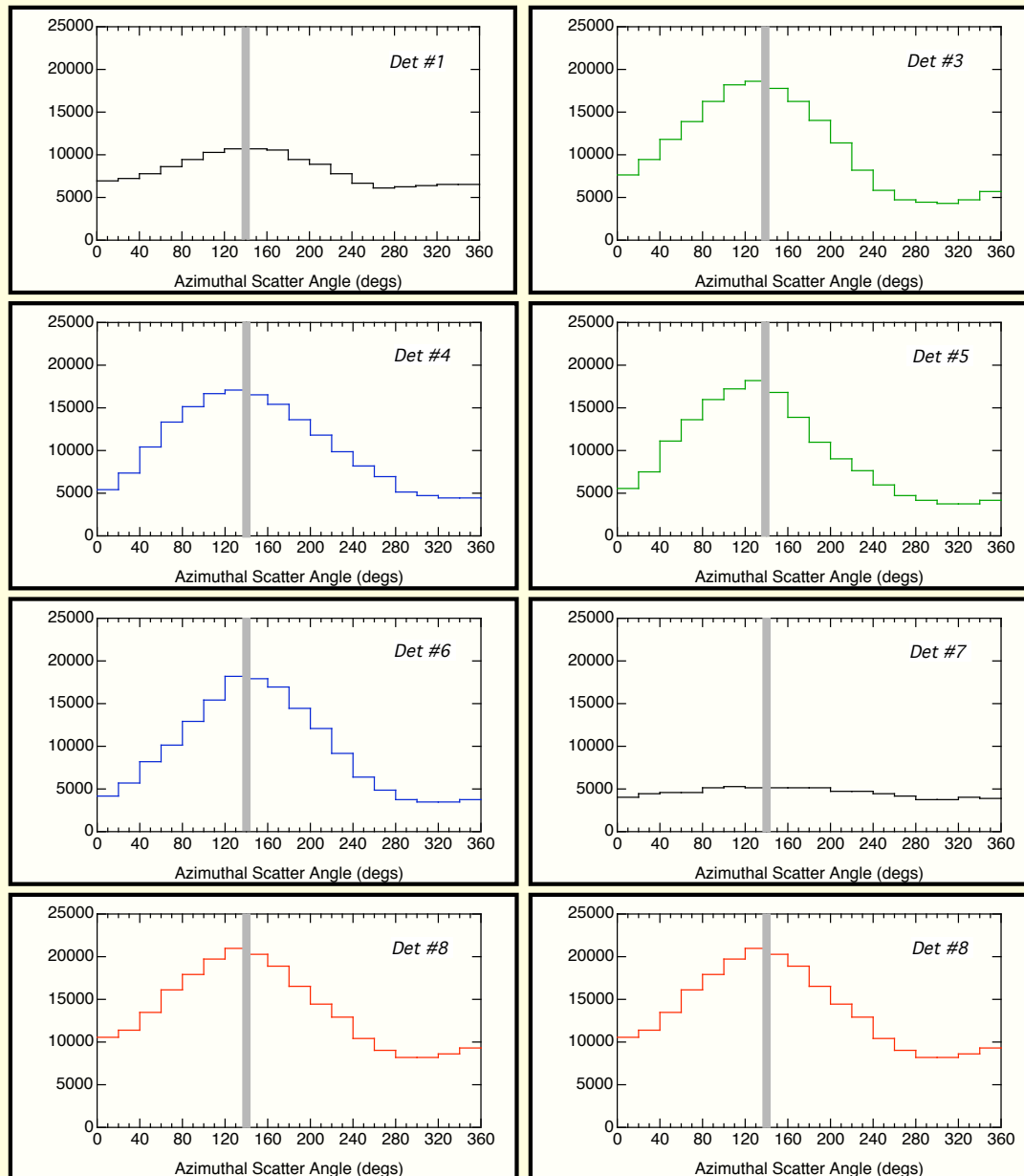

An Initial Approach to RHESSI Analysis

Three pairs of detectors with similar background :
detectors 8/9, detectors 3/5 and detectors 4/6.

The data from detectors 3-6 can be used as background estimate
for the polarimeter mode detectors 8/9.

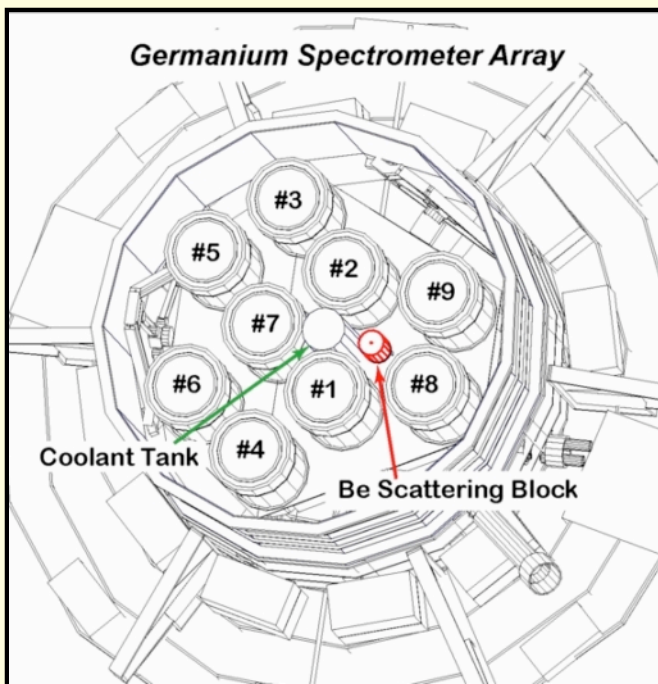

Limitations :

- Does not use detector #1
- Assumes symmetric geometry
- No modeling of Earth albedo

“Background” Subtracted Data

Non-Flare Interval, 17-Jul-2002, 17:32 - 17:45 UT

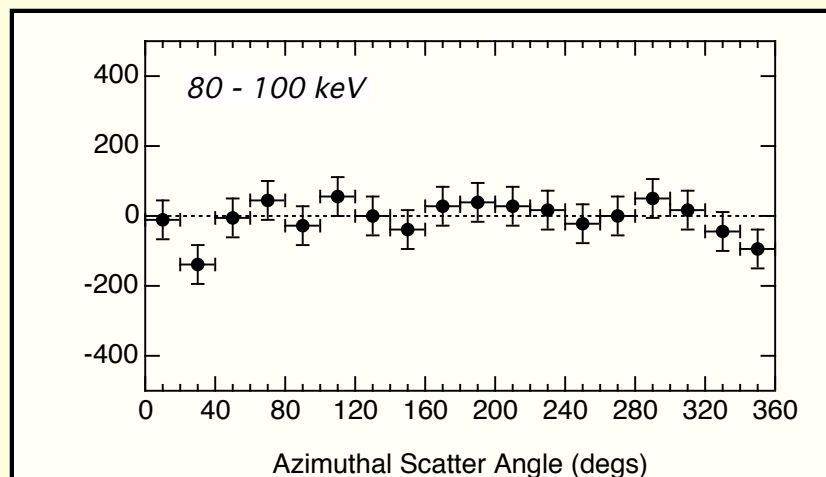
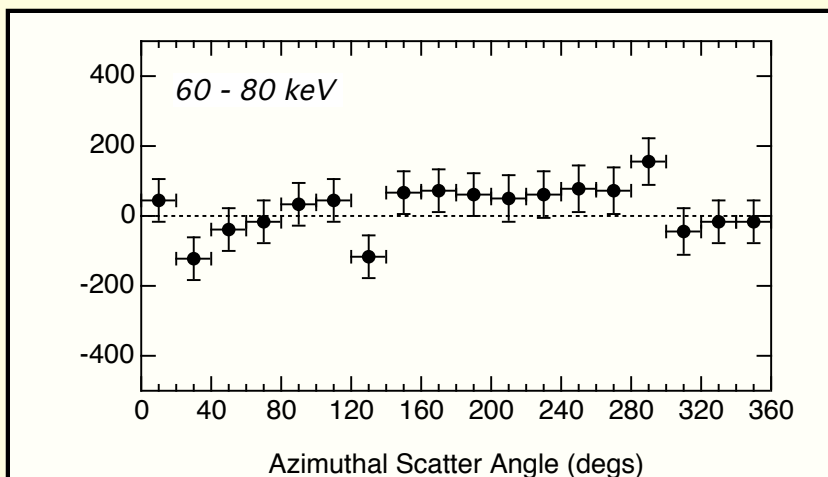
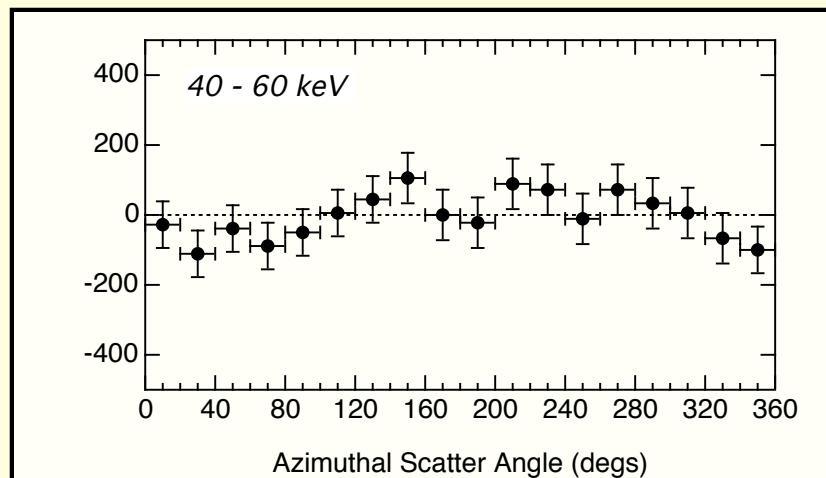
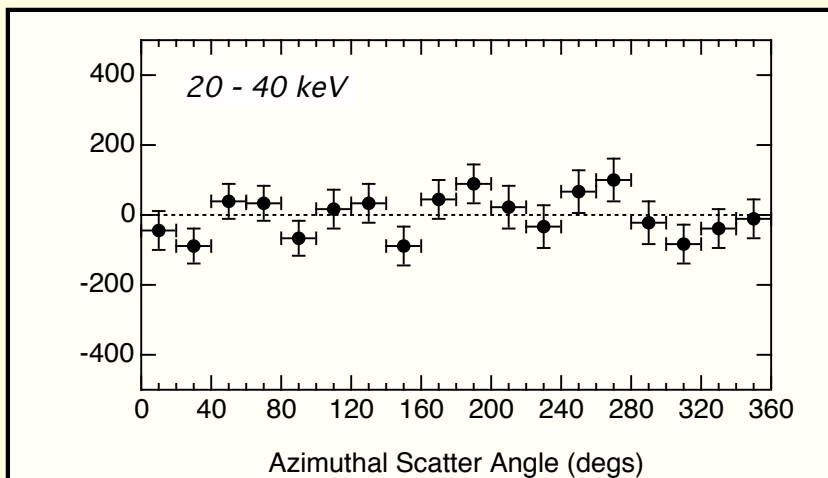

Normalization factors correct for relative detector efficiencies.

“Background” Subtracted Data

X4.8 Flare, 23 July 2002, 00:26 - 00:42 UT

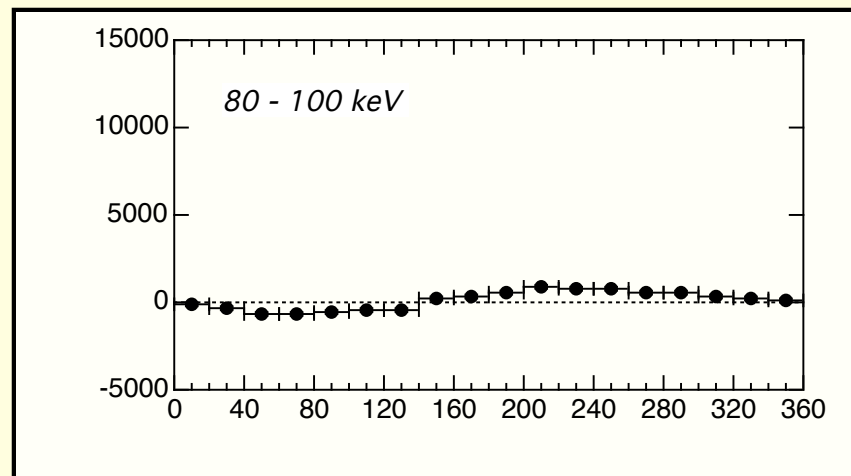
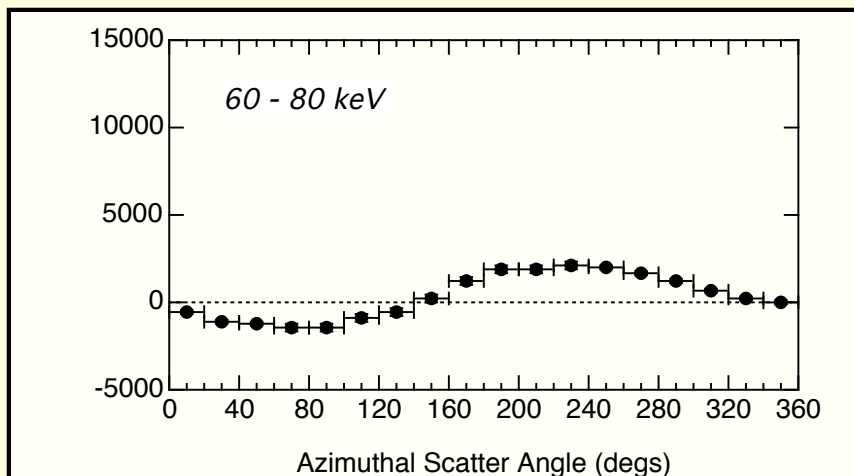
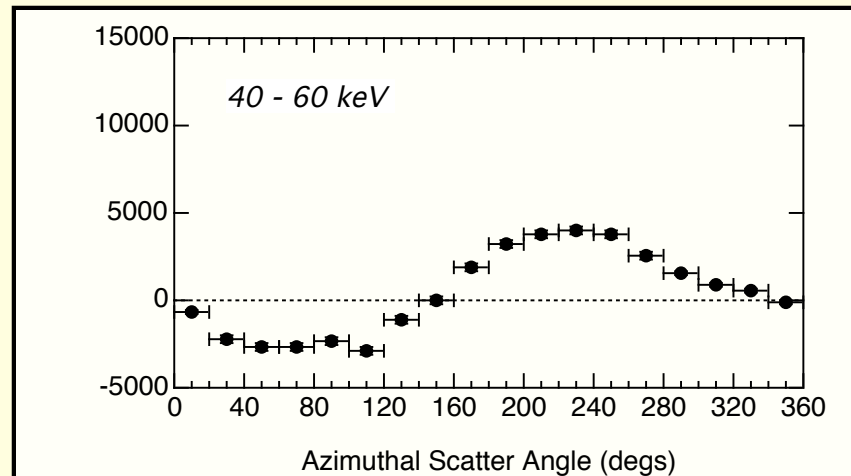
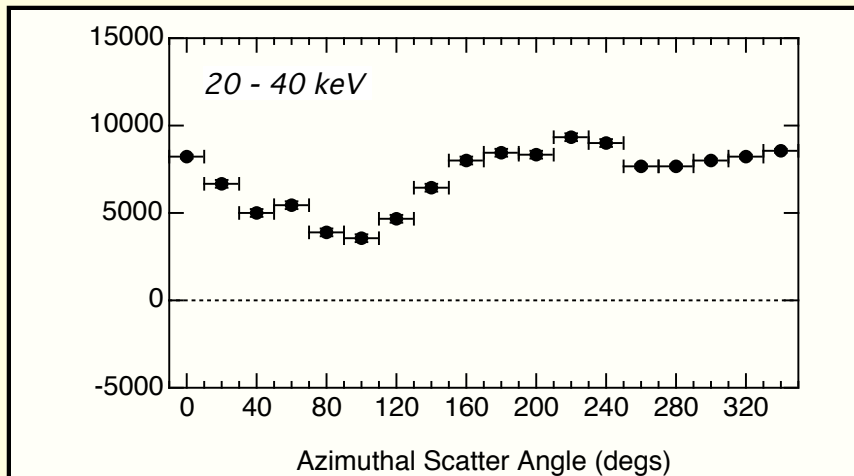

Polarization Analysis

Two Component Analysis

$$f(\theta) = \underbrace{A + B \sin 2(\theta - \theta_0)}_{\text{Polarization signal}} + \underbrace{C \sin \theta(\theta - \theta_0)}_{\text{Systematic Component}}$$

1. Systematic Component:

- Single sinusoid component.
- Dominates the response at high energies.
- Appears to be due to vignetting of the source by spacecraft rotation (collimation effects).
- This component averages to zero.

2. Polarization Signal

- Double sinusoid component.

Polarization Analysis : 20-40 keV

X4.8 Flare, 23 July 2002, 00:26 - 00:42 UT

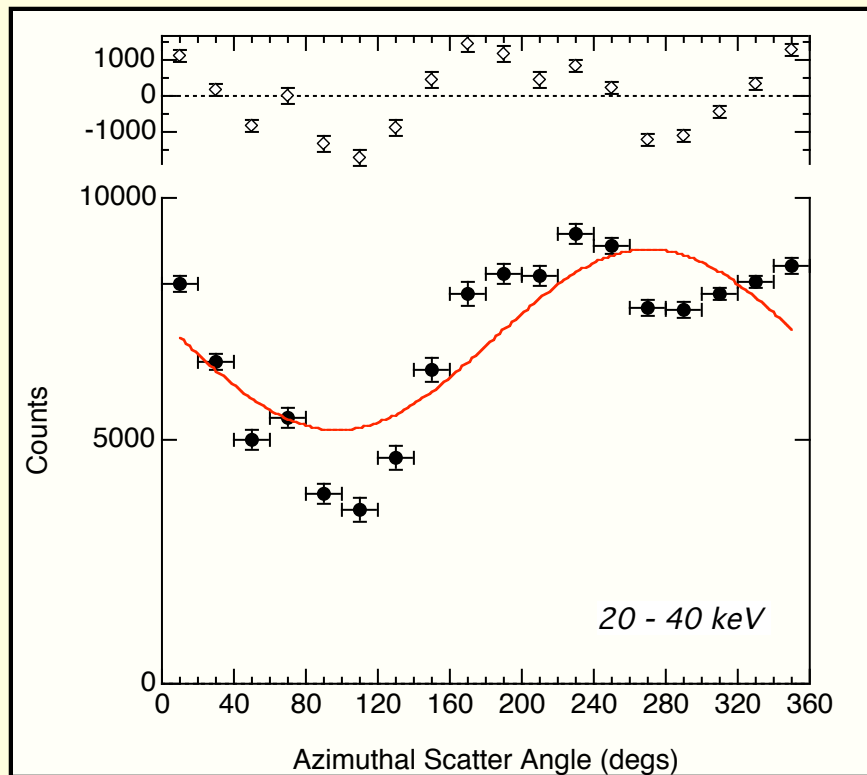

Systematic Component Only

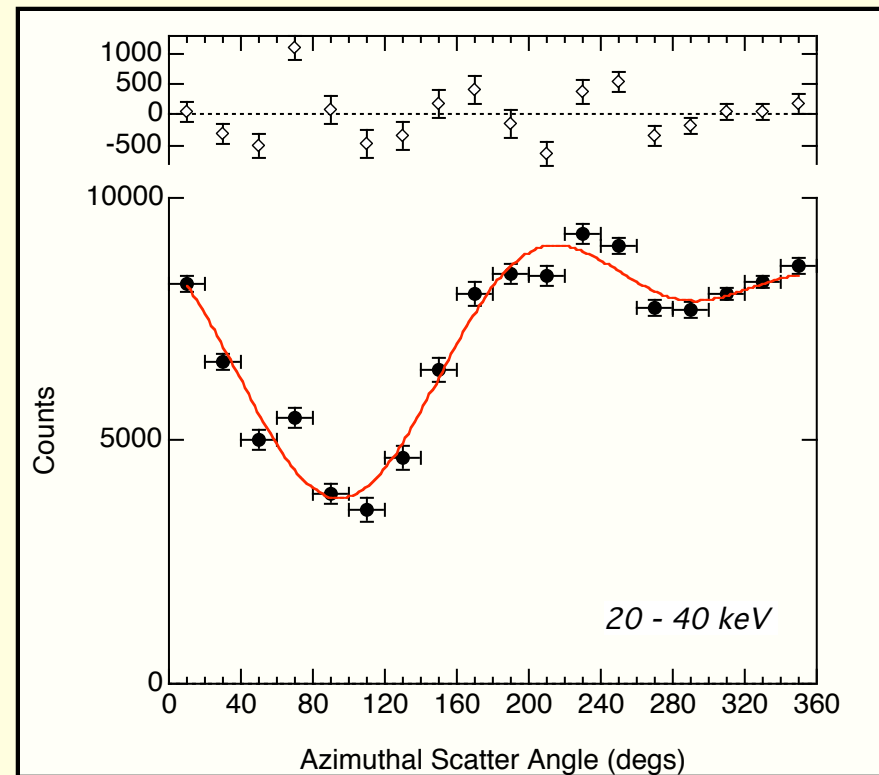

Systematic and Polarization
Components

Polarization Analysis : 40-60 keV

X4.8 Flare, 23 July 2002, 00:26 - 00:42 UT

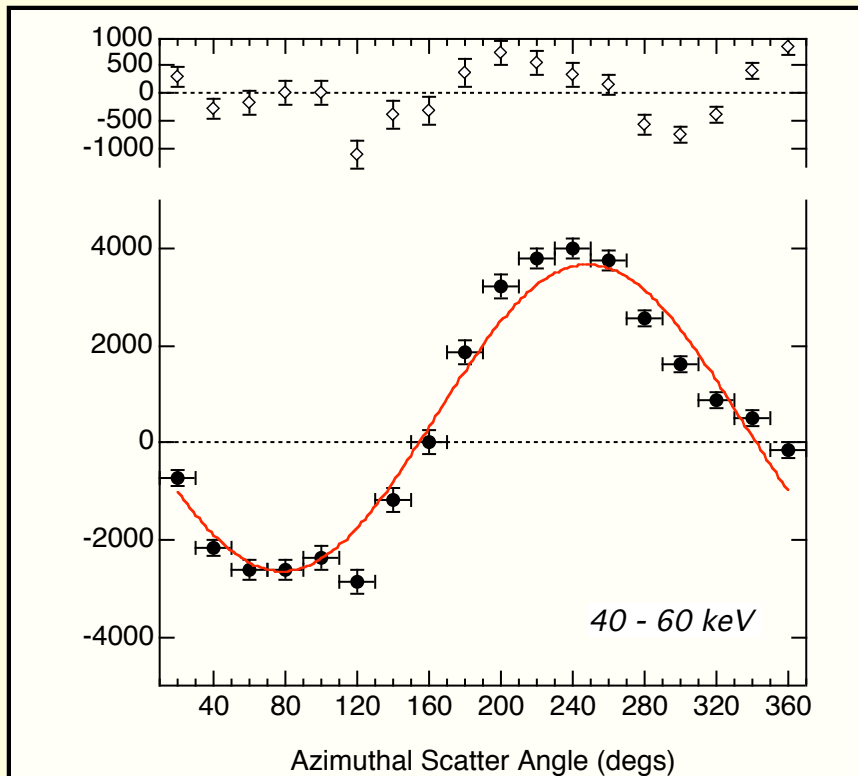

Systematic Component Only

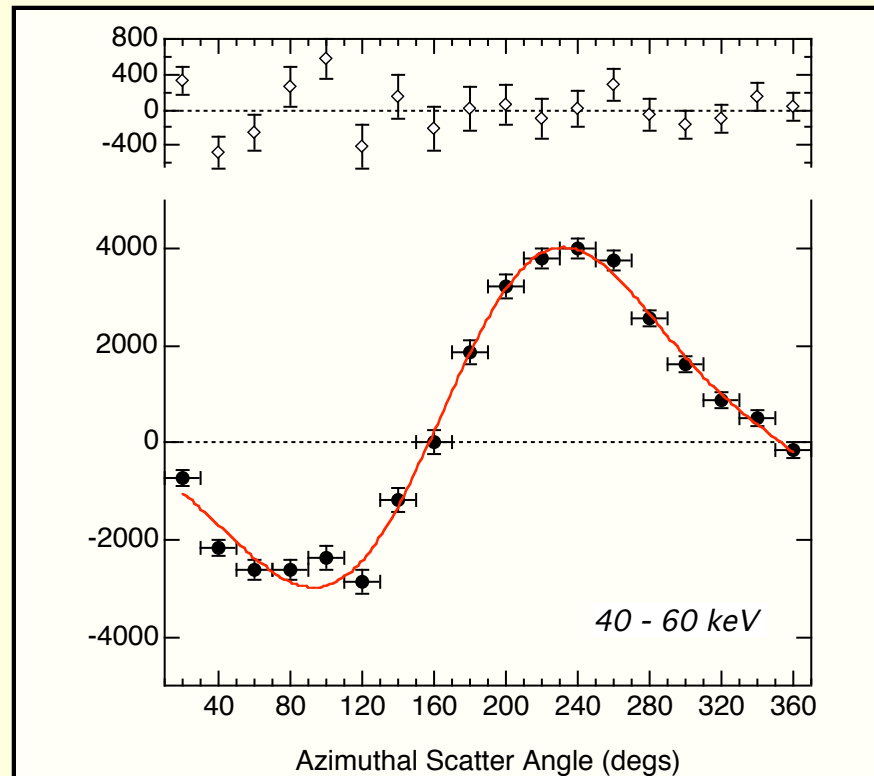

Systematic and Polarization
Components

Polarization Analysis : 60-80 keV

X4.8 Flare, 23 July 2002, 00:26 - 00:42 UT

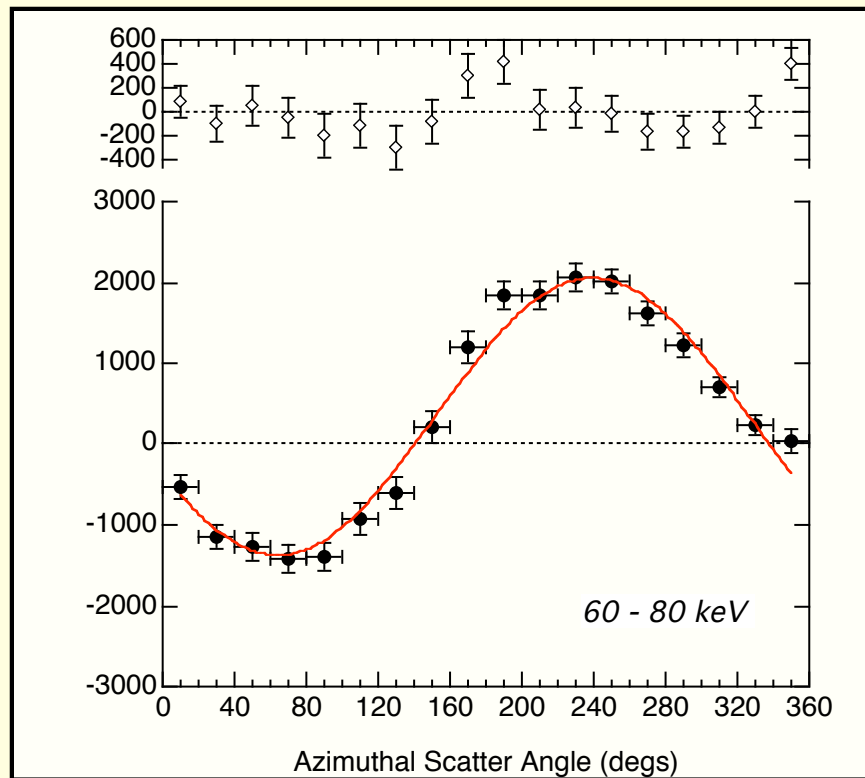

Systematic Component Only

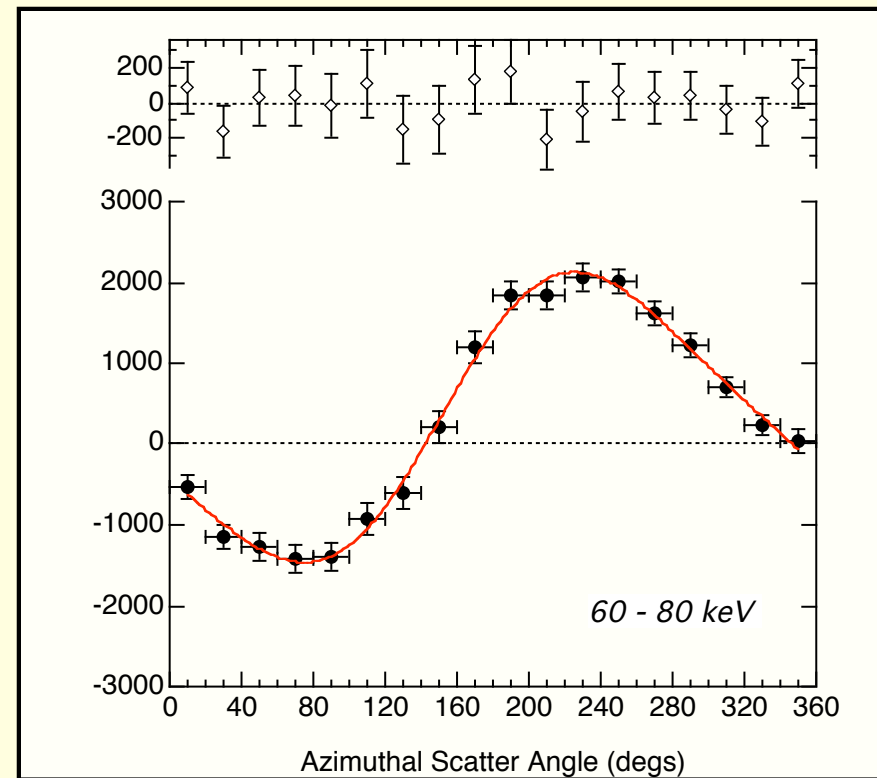

Systematic and Polarization
Components

Polarization Analysis : 80-100 keV

X4.8 Flare, 23 July 2002, 00:26 - 00:42 UT

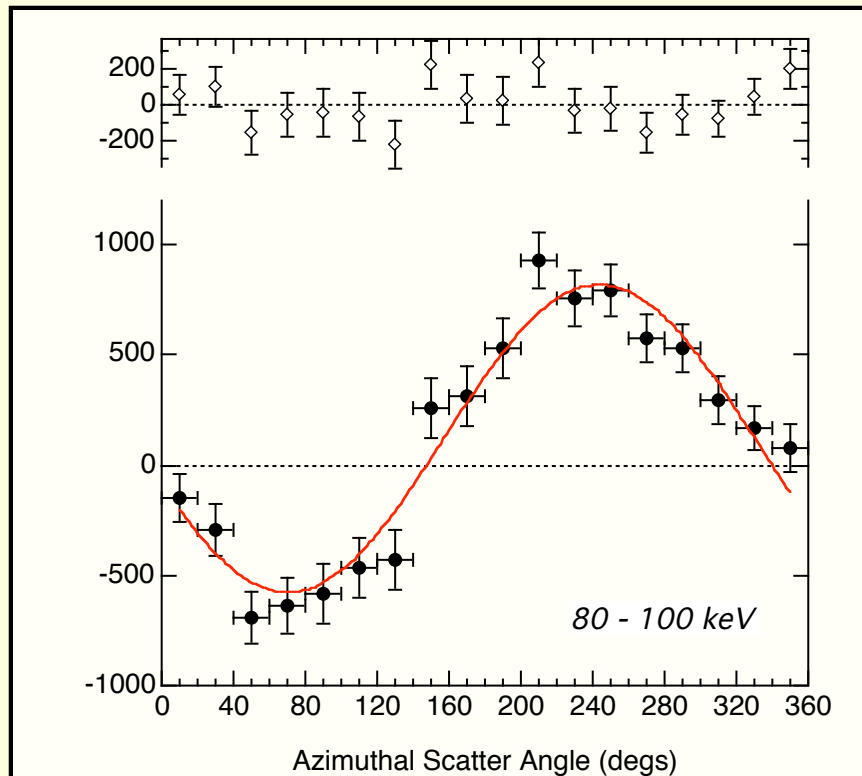

Systematic Component Only

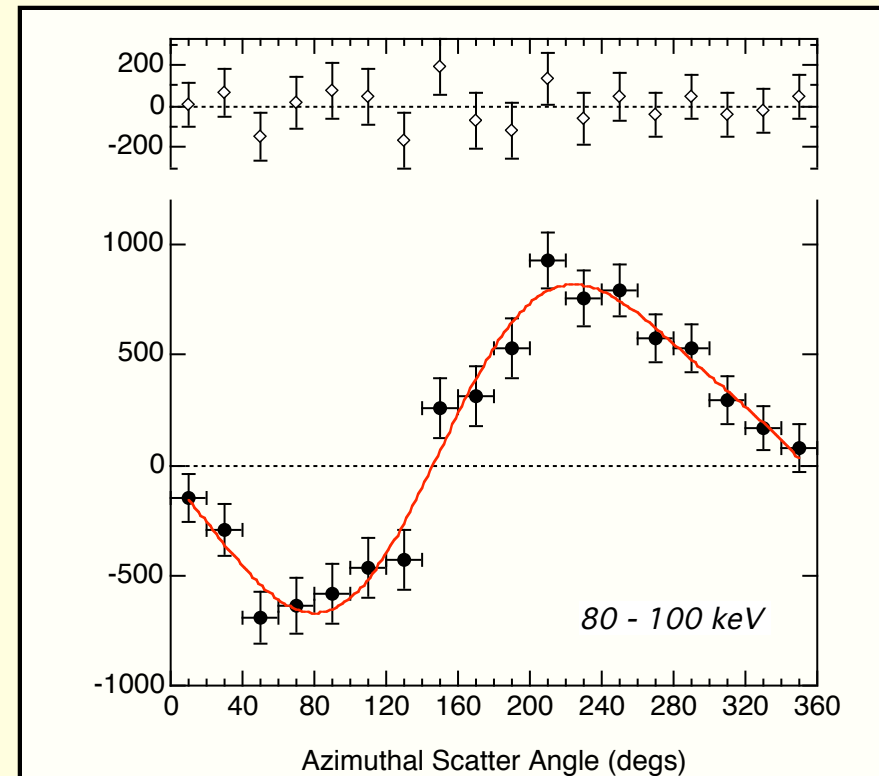

Systematic and Polarization
Components

Initial Polarization Results

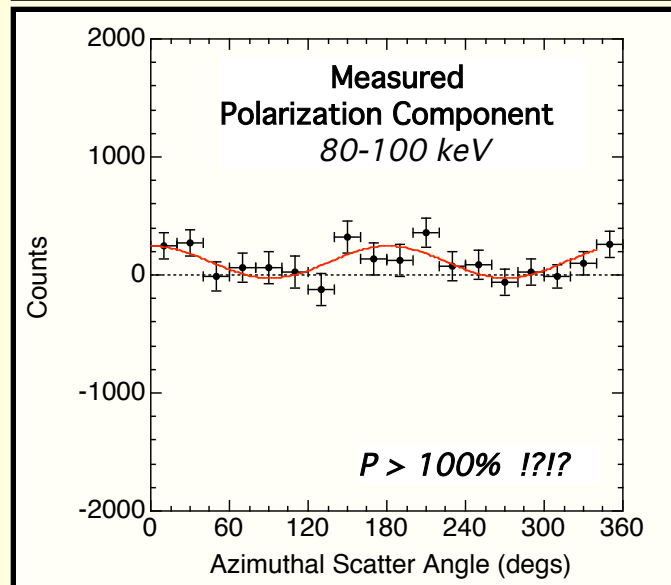
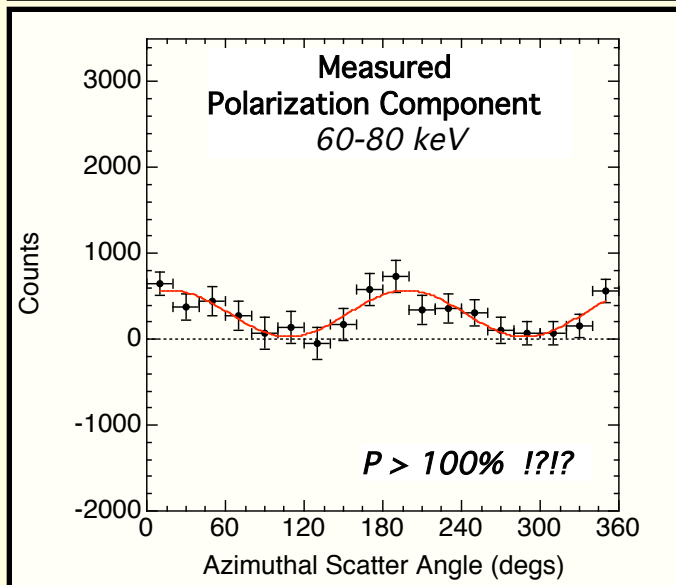
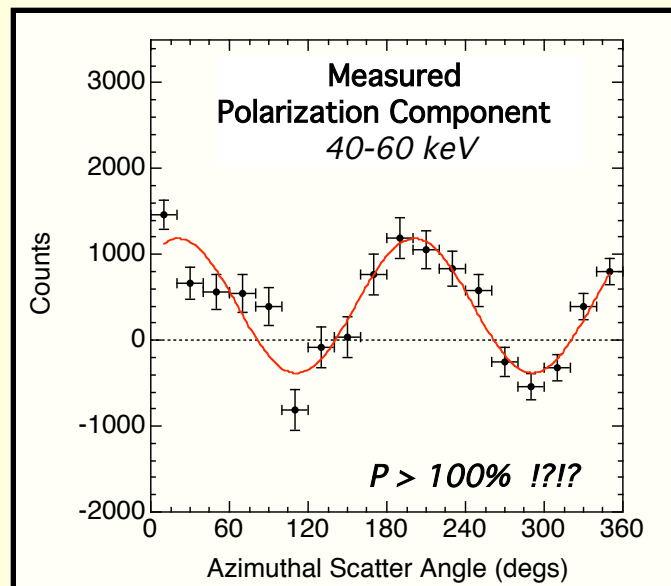
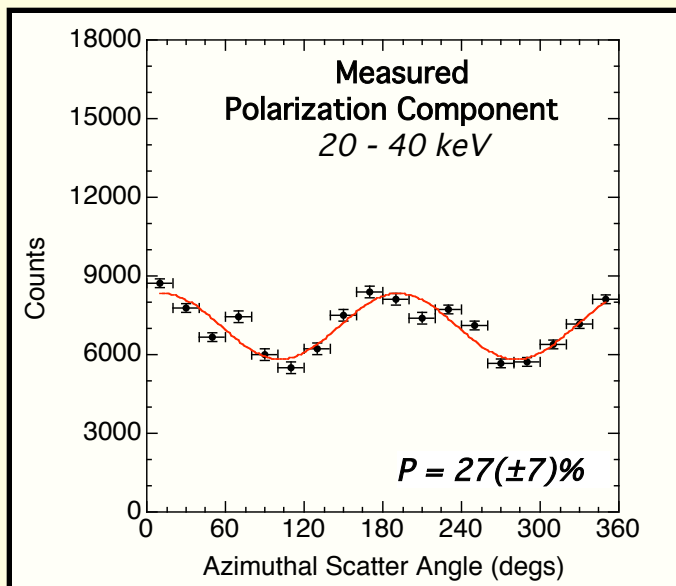

Corrections to Polarization Signal

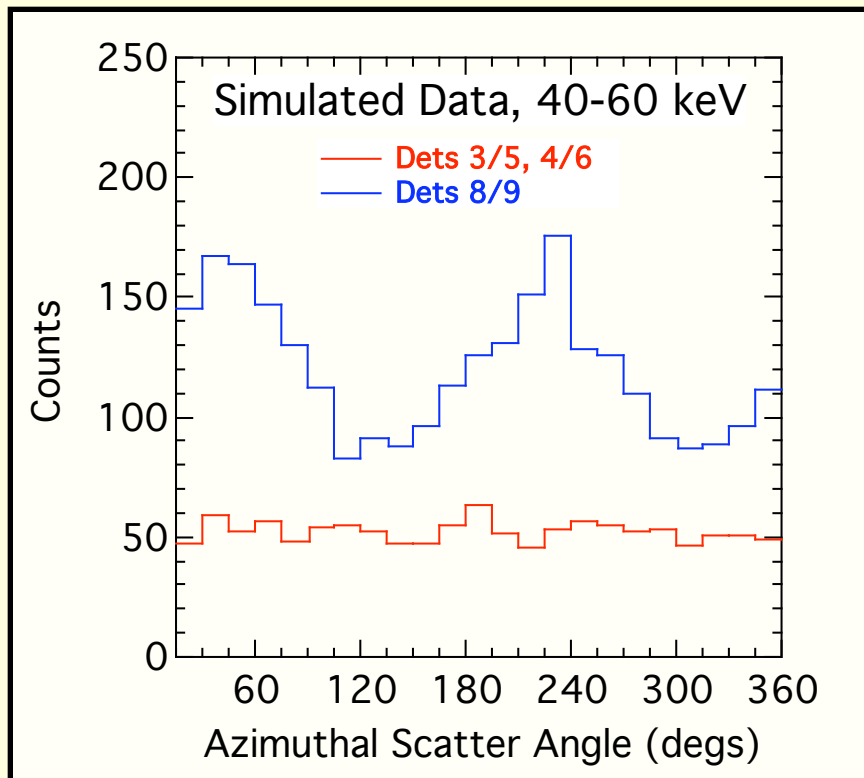

Solar counts in “background” signal (unmodulated).

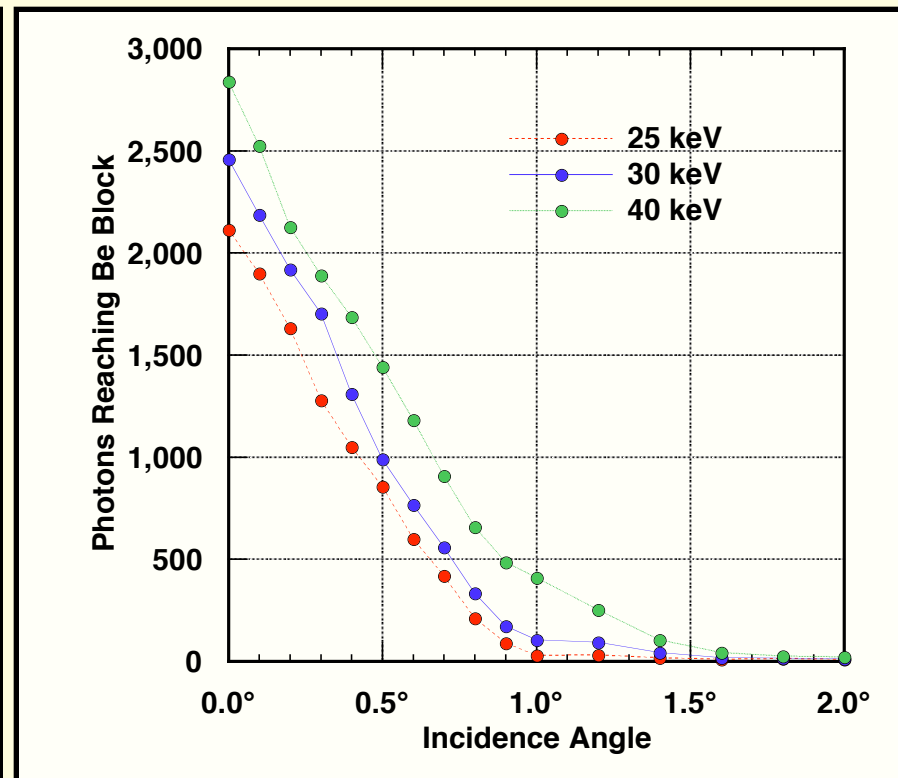

Attenuation due to off-axis location is about 25% for an event that is 10-15 arcmin off-axis.

Latest Polarization Results

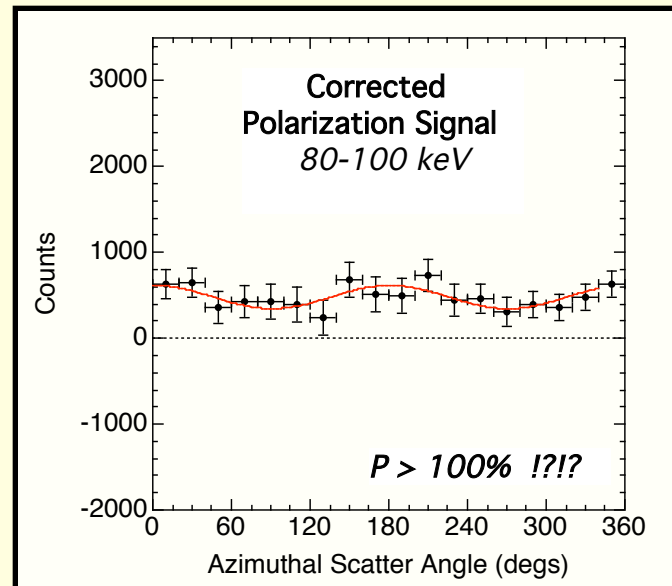
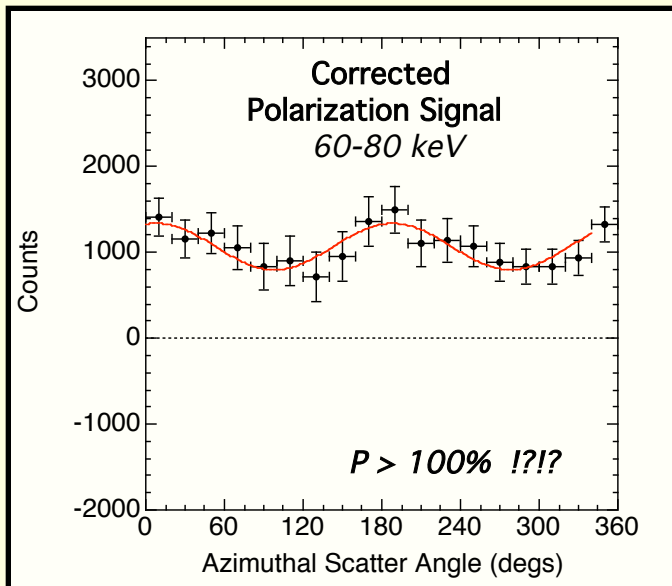
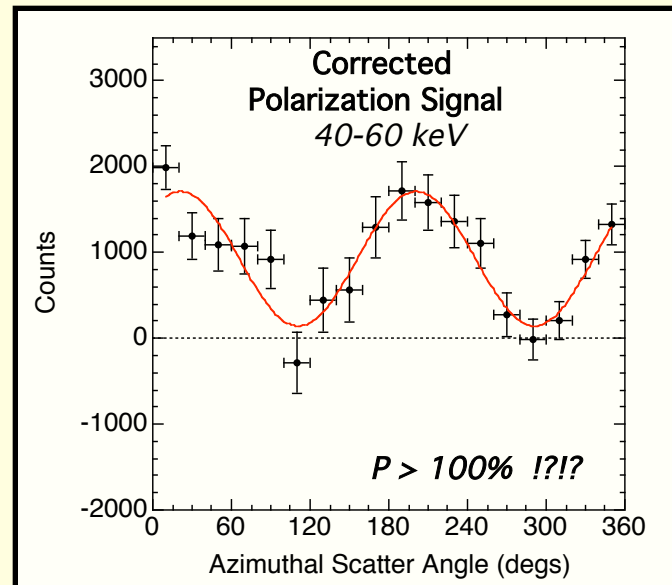
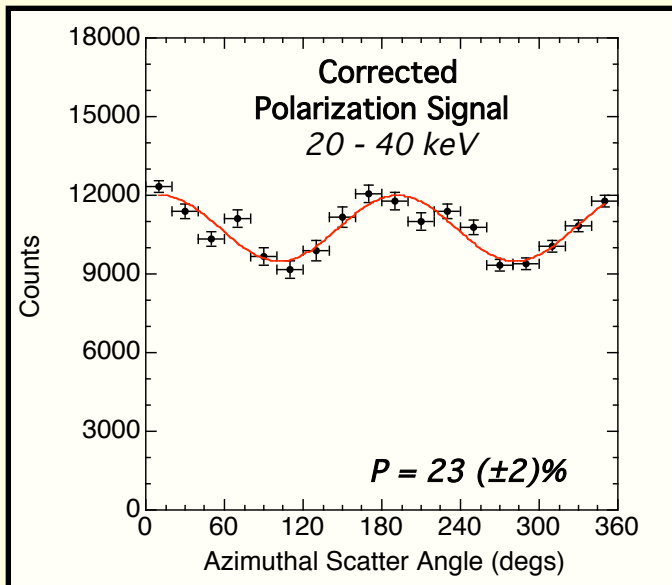

Summary

- Addition of a Be scattering block provides HESSI with significant polarimetric capability.
- Polarization sensitivity predicted to be less than a few percent for some X-class flares.
- Several X-class flares observed by RHESSI.
- Results from X4.8 flare of 23 July 2002:
 - ✓ Polarization signal for 20-40 keV suggests a very significant polarization level of ~23%.
 - ✓ Modulations seen at higher energies are difficult to explain (not consistent with polarization signal?).
 - ✓ Need to consider the detailed variation of the flare angle with respect to pointing axis along with variations in flare intensity...